



eTube Project
Operating Manual
(E-BIKE)

CONTENTS

NAMES OF PARTS	3
CUSTOMIZE	4
Drive unit setting	5
Display monitor settings.....	6
Switch setting.....	7
Switch mode setting	7
Switch function settings	8
Motor unit gear setting.....	9
ERROR CHECK	10
UNIT LOG ACQUISITION	11
ABOUT THIS DOCUMENT	12
REGISTERED TRADEMARKS AND TRADEMARKS.....	12

NAMES OF PARTS

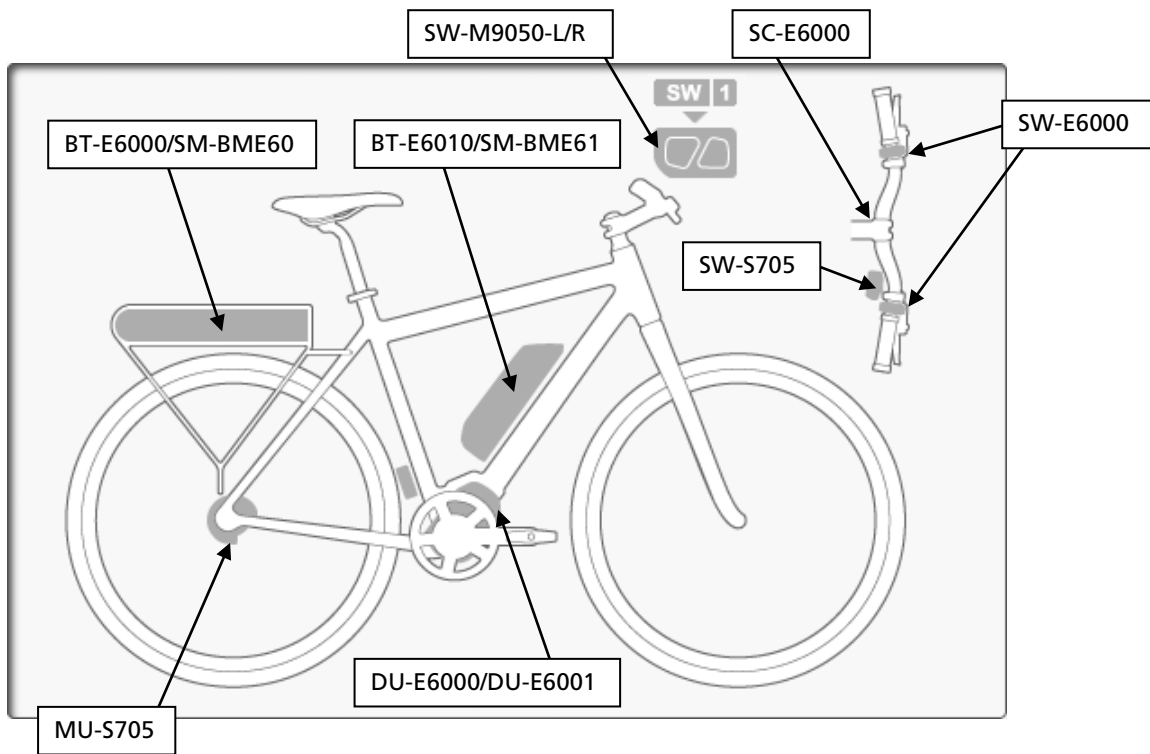

CUSTOMIZE

This function is used to customize the E-BIKE system.

1. Click [Customize] in the main menu screen.

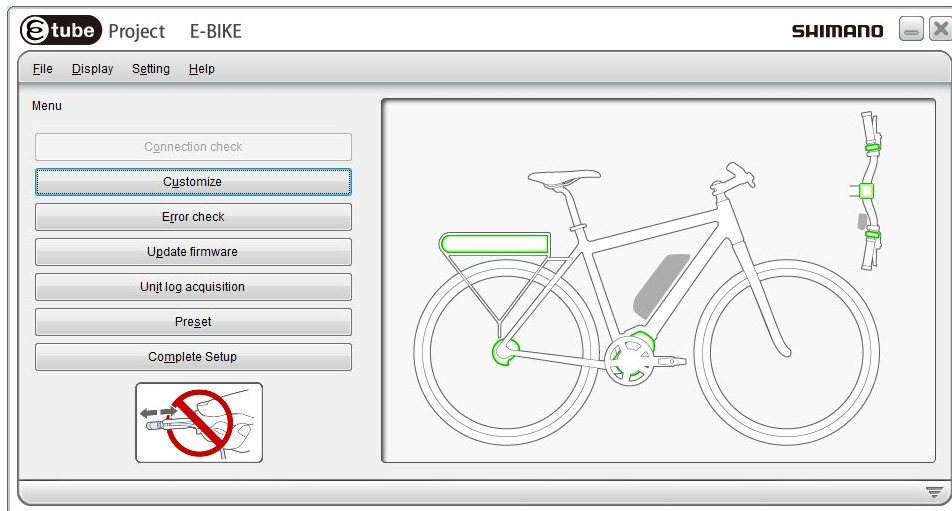

(Main menu screen)

2. Click [Drive unit setting], [Display monitor setting], [Switch setting], [Motor unit gear setting] in the customize menu screen to go to each setting screen.

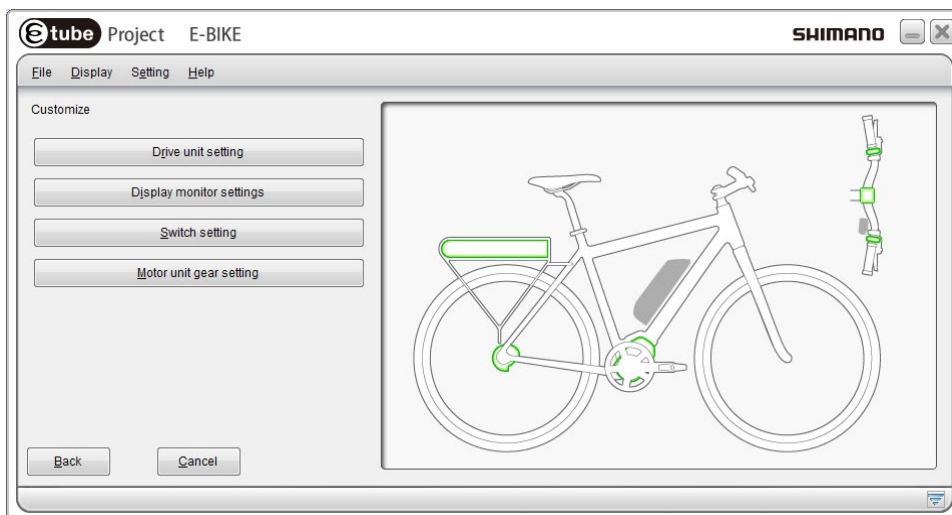

(Customize screen)

Drive unit setting

Configure the settings of the drive unit.

The following settings can be selected.

Item	Settings
Light connection	Select "Yes" when connecting a light or "No" when not connecting a light.
Start mode	Switches the start mode on or off. You can change gear position when on is selected.

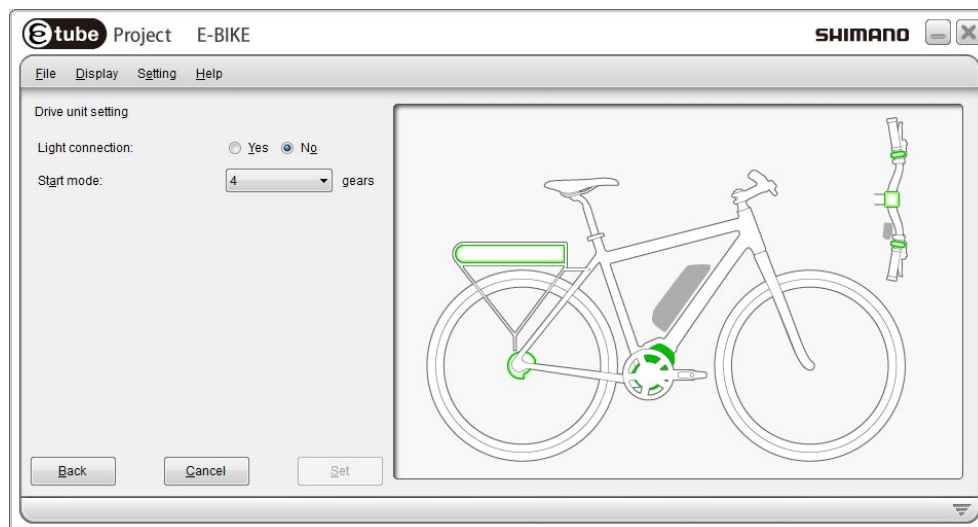

(Drive unit setting screen)

Display monitor settings

Configure the settings of the display monitor.

The following settings can be selected.

Item	Settings
Display units	You can select the International System (km) or the Imperial System (mile) of units.
Display switchover	You can select whether to display the items "Traveling time", "Average speed", "Maximum speed", and "Range overview".
Time setting	You can adjust the time setting.
Beep setting	You can select whether to turn the beep on or off.
Backlight setting	You can select whether to turn the backlight on, off or manual.
Display language	You can select the display language from "English", "French", "German", "Dutch", "Italian", and "Spanish".

- * Click [Restore default values] and then [Set] to reset the settings to default.

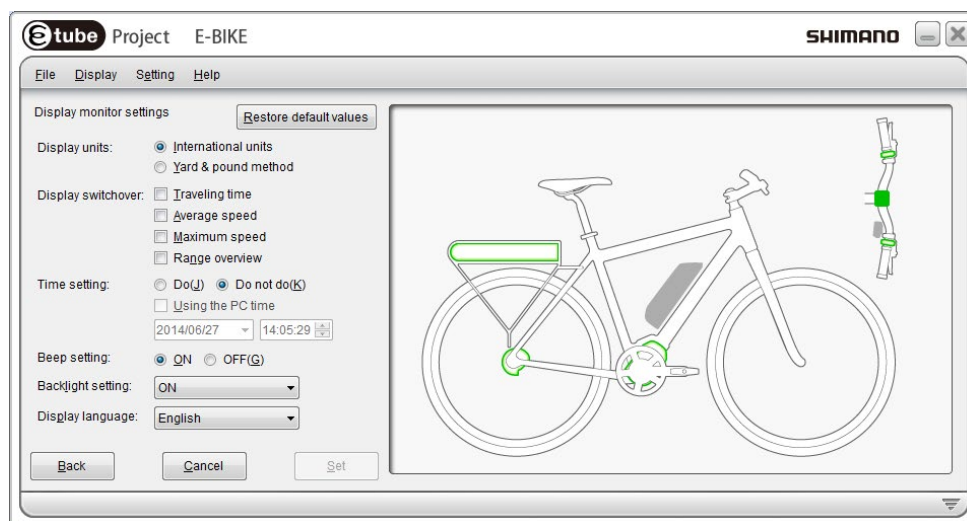

(Display monitor settings screen)

Switch setting

Click [Switch mode setting] or [Switch function setting] to go to each setting screen.

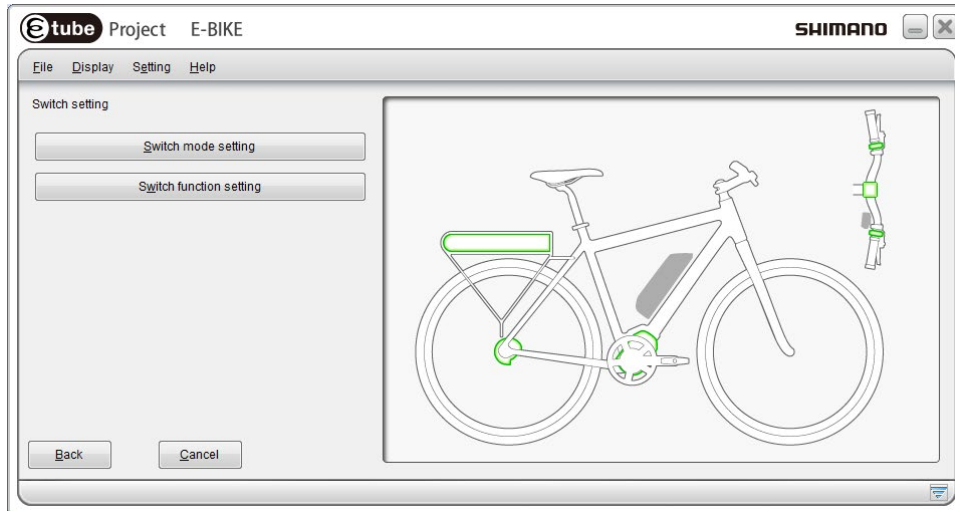

(Switch setting screen)

Switch mode setting

SW-E6000 can be used as the assist mode switch or gear shifting switch. You can select which mode to use.

On the E-tube Project screen, the assist mode switch is indicated as "SW-E6000 for Assist" and the gear shifting switch is indicated as "SW-E6000 for Shift".

Configure the setting according to the instructions displayed on the screen.

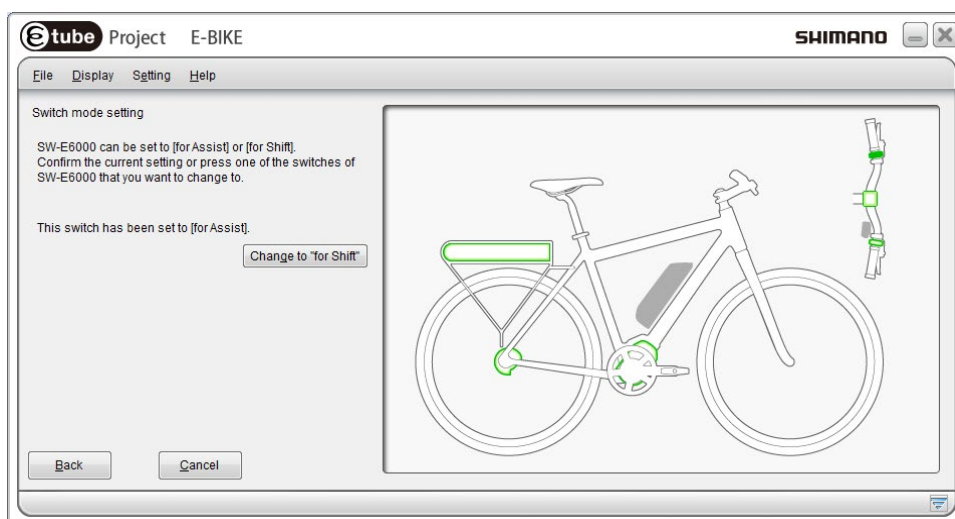

(Switch mode setting screen)

Switch function settings

You can change the functions to assign to switches (X), (Y) and (Z).

SW-E6000 for Assist

Pull-down menu	Description
Display/Light	Switch the screens of the display monitor. * Holding down the switch turns the light on or off.
ASSIST_UP	Raise the level of assistance in the assist mode.
ASSIST_DOWN	Lower the level of assistance in the assist mode.

- * This setting is effective only when "Yes" is selected for light connection in the drive unit setting.

SW-E6000 for Shift

Pull-down menu	Description
Display	Switch the screens of the display monitor.
SHIFT_UP	The derailleur shifts from a light gear to a heavier gear.
SHIFT_DOWN	The derailleur shifts from a heavy gear to a lighter gear.

- * Click [Restore default values] and then [Set] to reset the switch functions to default.

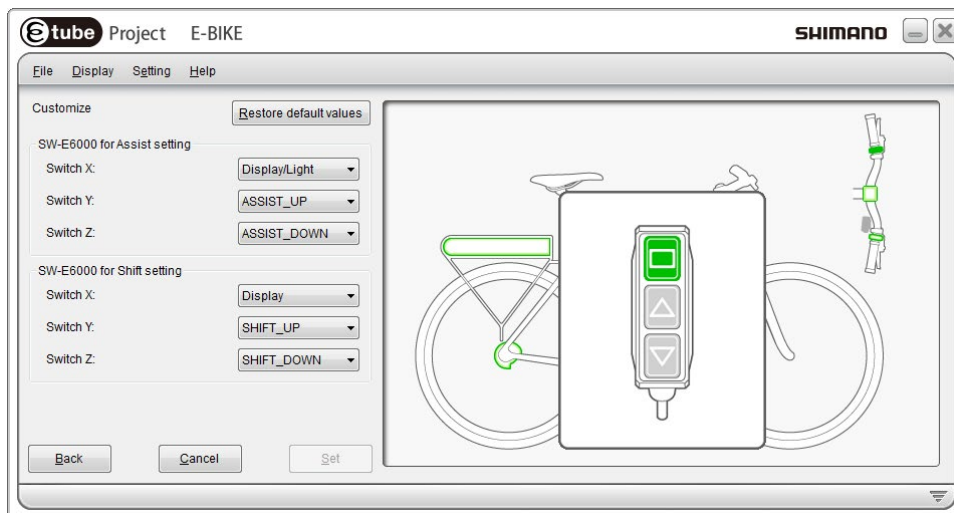

(Switch function settings screen)

Motor unit gear setting

MU-S705 can be used for hubs of SG-S705 (11 gears), SG-S505 (8 gears) and SG-C6060 (8 gears) by making additional settings. These settings can be made with the motor unit gear setting.

1. Display the customize menu screen.
2. Click [Motor unit gear setting] in the customize menu screen.
3. Click any setting and then [Set] in the motor unit gear setting screen.

The following settings can be selected.

Setting items	Description
8 gears	Select this when MU-S705 is installed to SG-S505 / SG-C6060.
11 gears	Select this when MU-S705 is installed to SG-S705.

- * Before making the motor unit gear setting, check the derailleur to be installed.

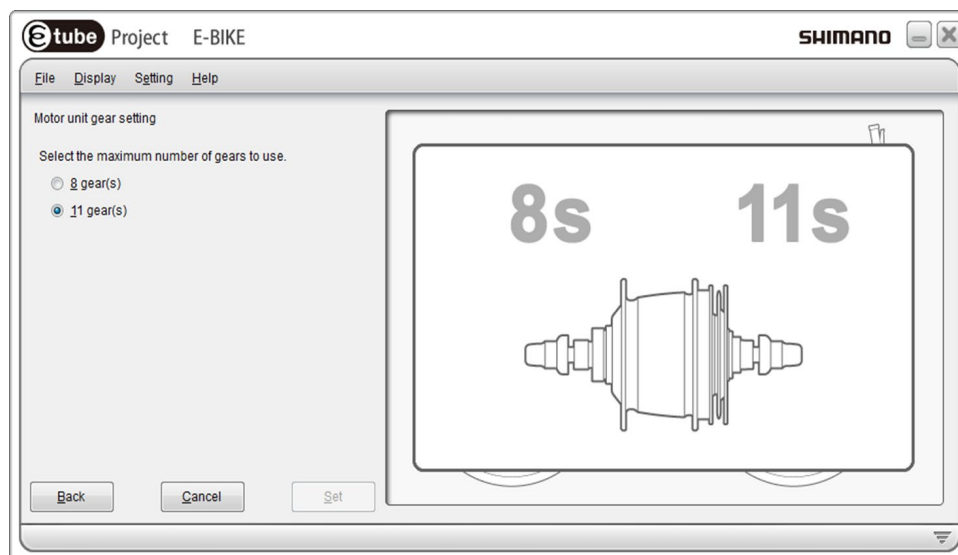

(Motor unit gear setting screen)

ERROR CHECK

When a single unit or multiple units are connected, this function checks their operation and identifies any units which have a problem.

Click [Error check] in the main screen to move to the error check screen.

Select the unit where its error check is performed and click [Next]. The error check of the selected unit is started. Perform operations following the instructions on the screen.

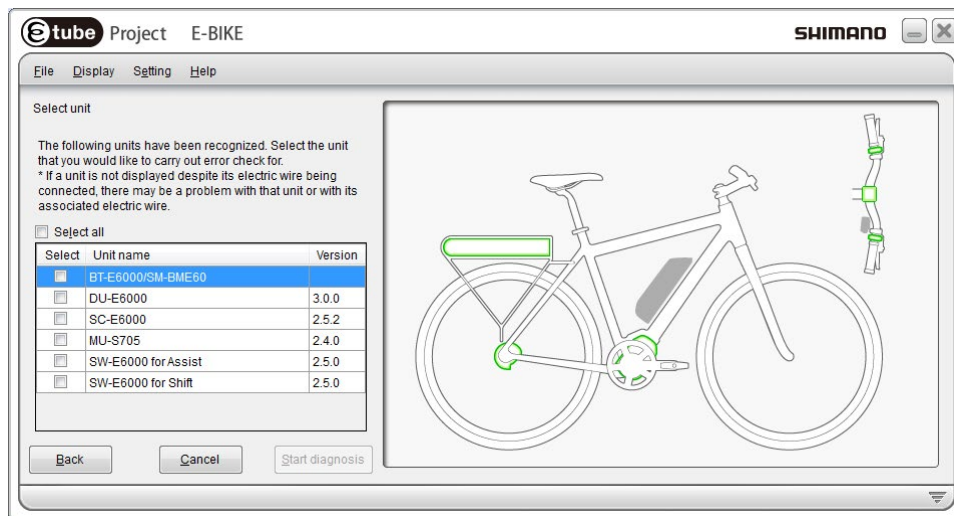

(Error check screen)

UNIT LOG ACQUISITION

Click [Unit log acquisition] on the main menu screen to acquire various kinds of data from the units connected and display it in a report format. In the report, you can check the settings of each unit and the battery status.

The report is displayed in PDF format.

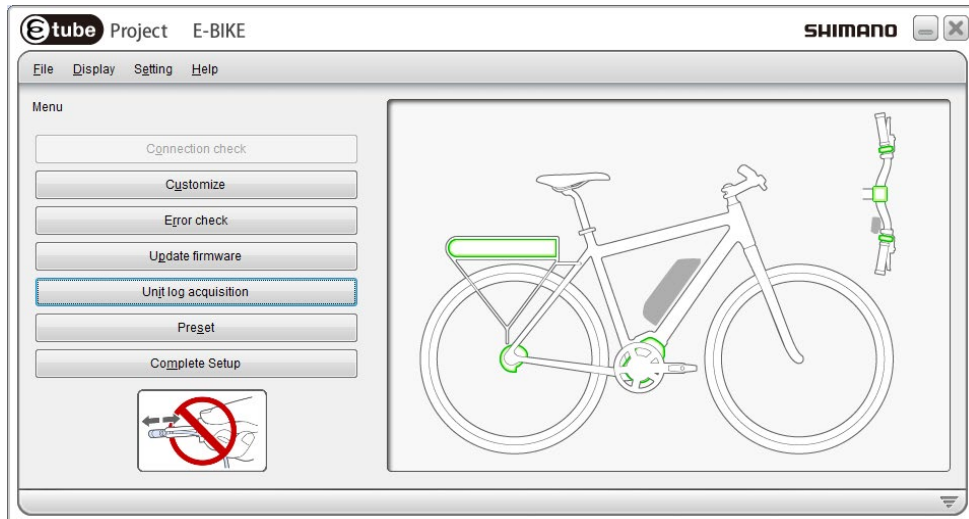

(Main menu screen)

ABOUT THIS DOCUMENT

The contents of this document are subject to revision in the future without notice.

Reproducing or transmitting this document in whole or in part in any form or for any purpose whatsoever without the express written permission of SHIMANO INC. is expressly forbidden. However, this is not to be taken as a limit on the customer's rights under applicable copyright laws.

SHIMANO INC. may own the rights to any patents, patent applications, trademarks, copyrights and any other intangible property rights contained in this document. Unless otherwise specified, the customer is not granted rights to any patents, trademarks, copyrights or any other intangible intellectual property contained in this document.

REGISTERED TRADEMARKS AND TRADEMARKS

Shimano is a trademark or registered trademark of SHIMANO INC. in Japan and other countries.

 Project is a trademark of SHIMANO, INC. in Japan and other countries.

Microsoft®, Windows® XP, Windows Vista™, Windows® 7, Windows® 8 are registered trademarks or trademarks of Microsoft Corporation in the United States of America and other countries.

All other company names, product names and service names, etc. are the property of their respective owners.

SHIMANO

SHIMANO AMERICAN CORPORATION

One Holland, Irvine, California 92618, U.S.A. Phone: +1-949-951-5003

SHIMANO EUROPE B.V.

Industrieweg 24, 8071 CT Nunspeet, The Netherlands Phone: +31-341-272222

SHIMANO INC.

3-77 Oimatsu-cho, Sakai-ku, Sakai-shi, Osaka 590-8577, Japan

Please note: specifications are subject to change for improvement without notice. (English)